









NO PART OF THIS DOCUMENT MAY BE REPRODUCED WITHOUT PRIOR AGREEMENT AND WRITTEN PERMISSION OF
 FORD PERFORMANCE PARTS © Ford Motor Company 2020

PRIOR TO INSTALLATION READ THESE INSTRUCTION COMPETELY
For questions, Call the FORD PERFORMANCE Techline 1-800-367-3788

Please visit <https://www.performanceparts.ford.com> for warranty information

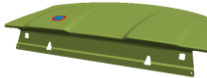
Note: It does not applicable for Model Year 2021 Mustang forward

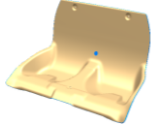
KIT ITEM

S.No	Item Description	Quantity	Picture
1	Center luggage fixing rivet nut (Note: This will require a rivet nut tool for installation)	1	
2	Center luggage fixing bolt (3 Nos)	3	
3	Cover Body Side Trim panel Right hand side	1	
4	Cover Body Side Trim panel Left hand side	1	
5	Parcel shelf or Parcel tray	1	
6	Foam blocks	2	
7	Center Luggage Cover	1	
8	Parcel Shelf to Package Tray push pins	2	

Ford Factory Shop Manual purchase options www.motorcraftservice.com

NO PART OF THIS DOCUMENT MAY BE REPRODUCED WITHOUT PRIOR AGREEMENT AND WRITTEN PERMISSION OF
FORD PERFORMANCE PARTS © Ford Motor Company 2020

INTERIOR REMOVAL

1. On both sides. Move the front seat to the full forward position. Tilt Chair Forward

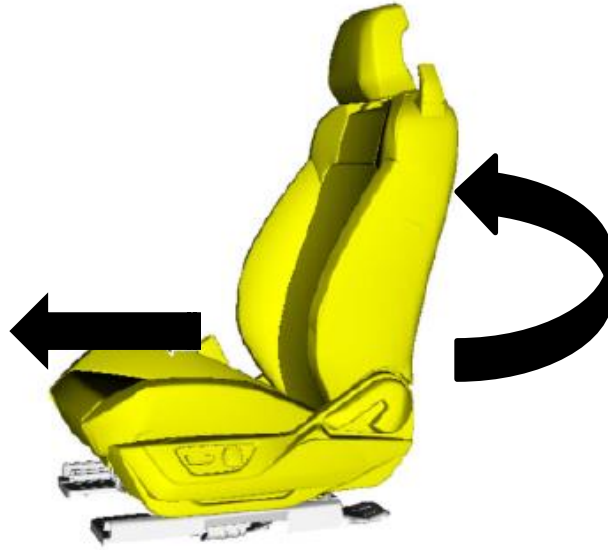

2. The seat cushion tabs must be pressed in to release them from the floor. If the locking tabs are not pressed in, it may result in damage to the tabs.

Located at the front of the seat cushion, press in on the locking tabs to release the seat cushion from the floor.

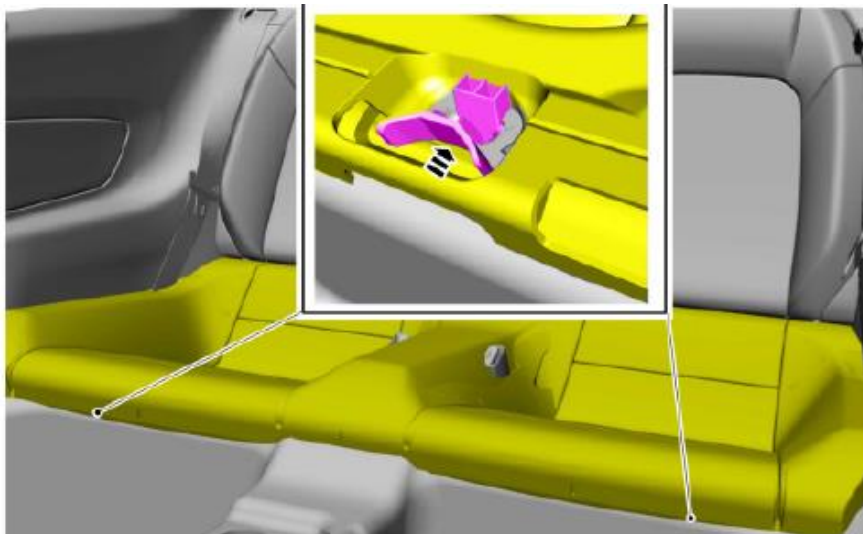

Ford Factory Shop Manual purchase options www.motorcraftservice.com

NO PART OF THIS DOCUMENT MAY BE REPRODUCED WITHOUT PRIOR AGREEMENT AND WRITTEN PERMISSION OF FORD PERFORMANCE PARTS © Ford Motor Company 2020

3. Lift and release the seat cushion. Remove the seat cushion.

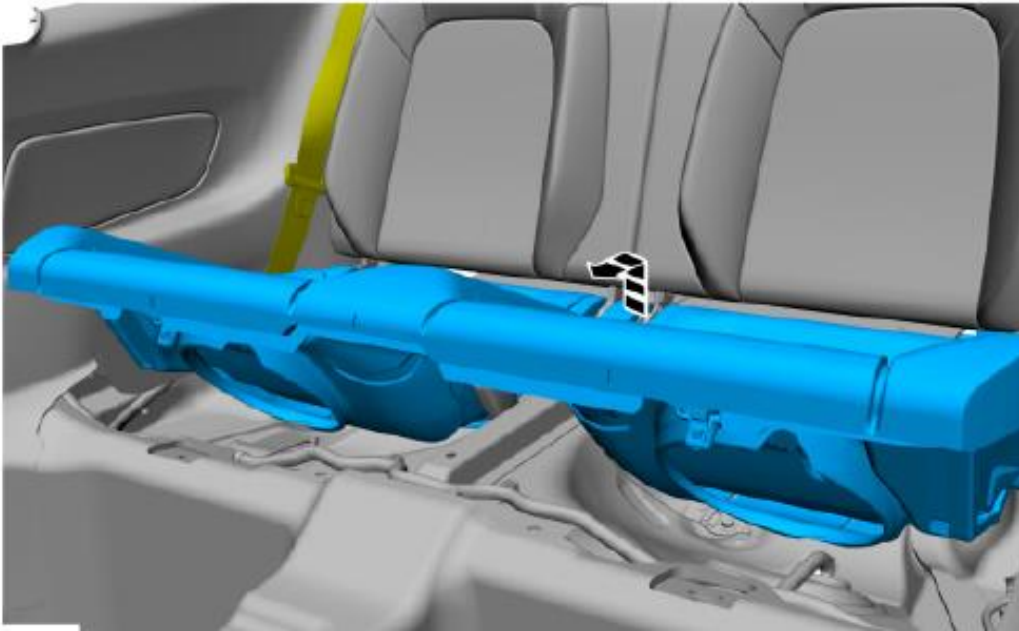

4. *LH seat shown, RH seat similar.* Remove the nut attaching the seat backrest to the floor.



Ford Factory Shop Manual purchase options www.motorcraftservice.com

NO PART OF THIS DOCUMENT MAY BE REPRODUCED WITHOUT PRIOR AGREEMENT AND WRITTEN PERMISSION OF
FORD PERFORMANCE PARTS © Ford Motor Company 2020

5. Release the latch and position the seat backrest down.



Ford Factory Shop Manual purchase options www.motorcraftservice.com

NO PART OF THIS DOCUMENT MAY BE REPRODUCED WITHOUT PRIOR AGREEMENT AND WRITTEN PERMISSION OF FORD PERFORMANCE PARTS © Ford Motor Company 2020

6. Remove the backrest and floor stud. *LH seat shown, RH seat similar.*
 1. Release the backrest hinge from the pivot hinge.
 2. Move the safety belt aside. Rotate the backrest toward the outboard side of the vehicle.
 3. Lift the backrest to release it from the floor stud. Remove the backrest.
 4. Remove floor stud after backrest is removed



Ford Factory Shop Manual purchase options www.motorcraftservice.com



FORD PERFORMANCE

M-6346612-GT

Model Year 2018, 2019 and 2020

Product Name: Mustang rear seat deletion kit OE

NO PART OF THIS DOCUMENT MAY BE REPRODUCED WITHOUT PRIOR AGREEMENT AND WRITTEN PERMISSION OF FORD PERFORMANCE PARTS © Ford Motor Company 2020

7. Remove rear seat floor panel hinge

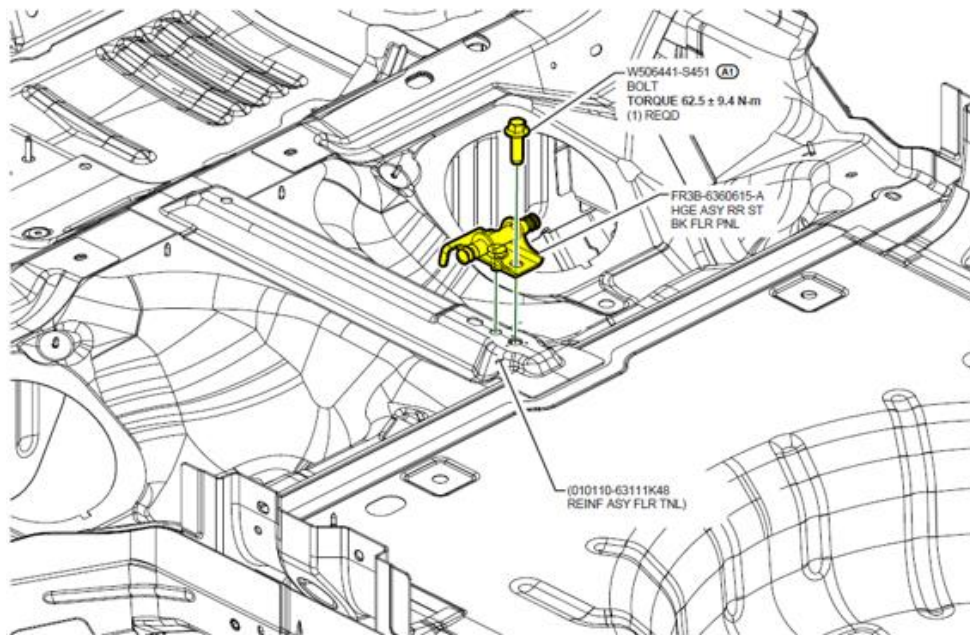

Ford Factory Shop Manual purchase options www.motorcraftservice.com

NO PART OF THIS DOCUMENT MAY BE REPRODUCED WITHOUT PRIOR AGREEMENT AND WRITTEN PERMISSION OF FORD PERFORMANCE PARTS © Ford Motor Company 2020

8. Remove the retainers and the child safety seat tether anchors. *RH shown, LH similar.*

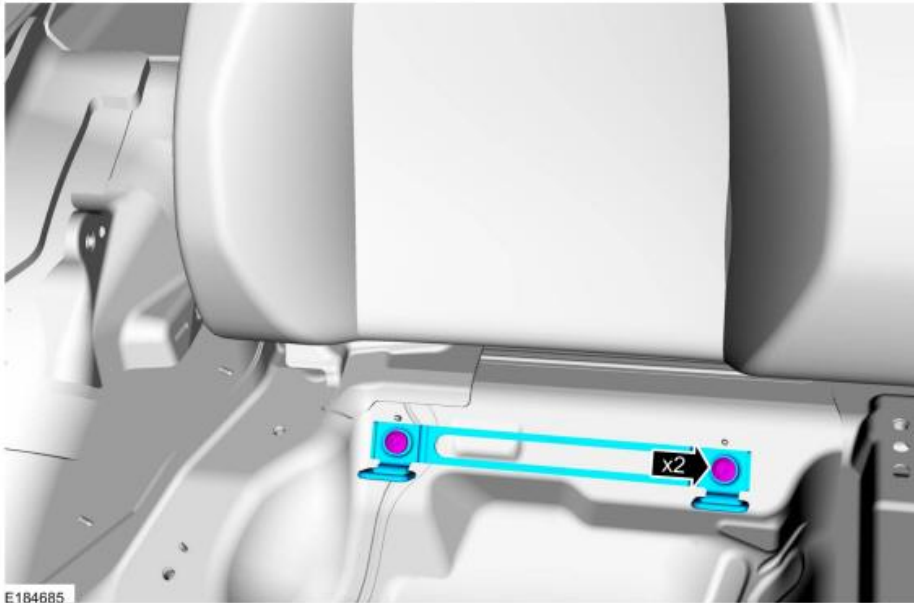

9. Remove the bolt and the safety belt buckle. *RH shown, LH similar.*

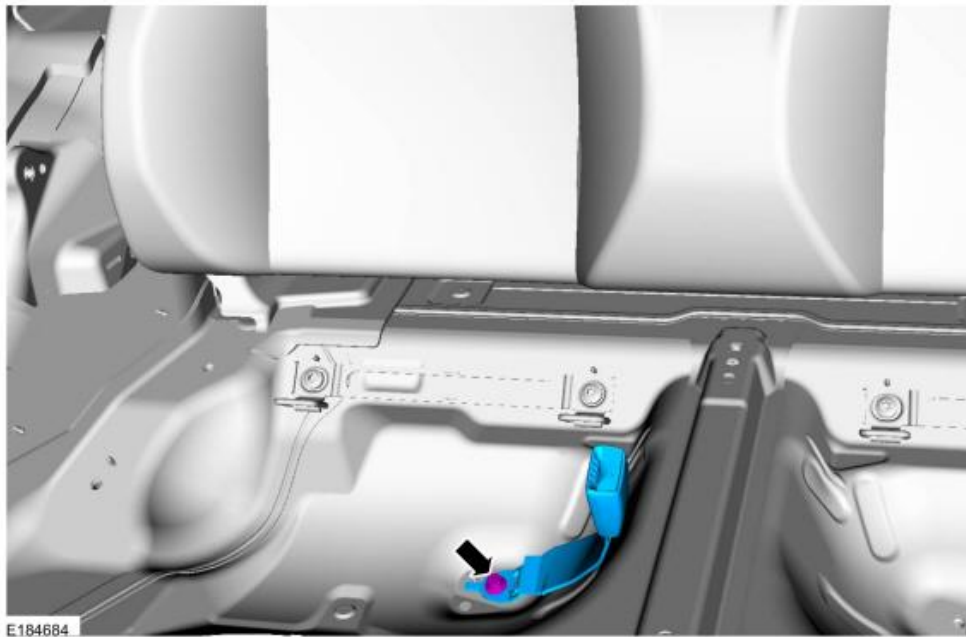

Ford Factory Shop Manual purchase options www.motorcraftservice.com



FORD PERFORMANCE

M-6346612-GT

Model Year 2018, 2019 and 2020

Product Name: Mustang rear seat deletion kit OE

NO PART OF THIS DOCUMENT MAY BE REPRODUCED WITHOUT PRIOR AGREEMENT AND WRITTEN PERMISSION OF FORD PERFORMANCE PARTS © Ford Motor Company 2020

10. *RH shown, LH similar.* Remove the bolt and position the seatbelt aside.

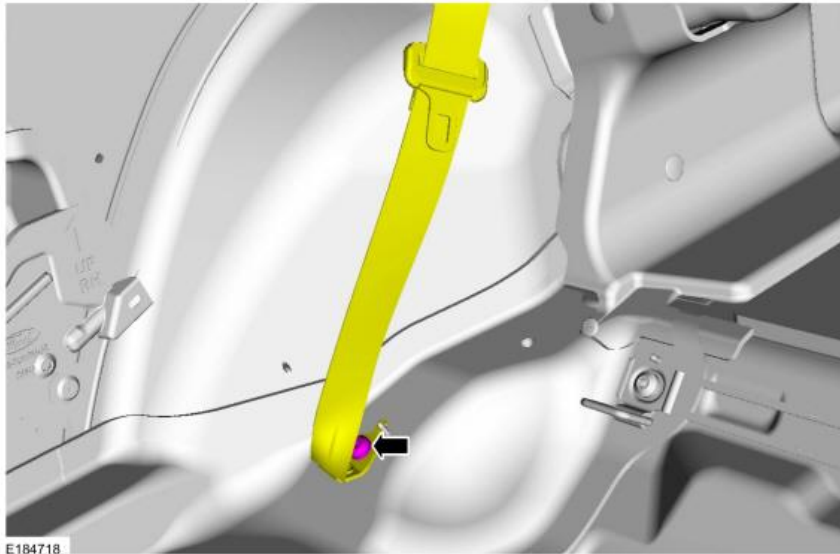

11. On both sides. *RH side shown, LH side similar.*
Release the clips, disconnect the tether clip and remove the C-pillar trim panel. Don't break the clips during assembly and disassembly

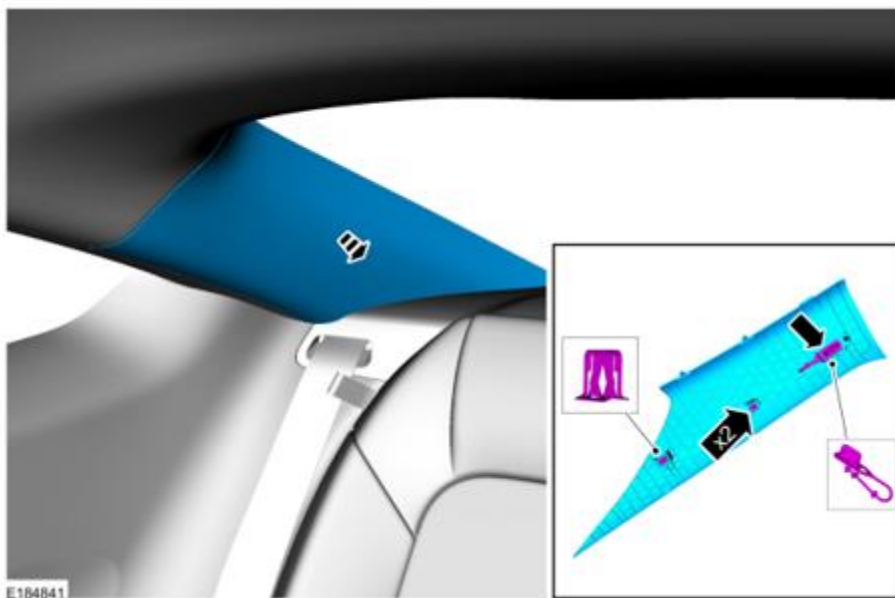

Ford Factory Shop Manual purchase options www.motorcraftservice.com

NO PART OF THIS DOCUMENT MAY BE REPRODUCED WITHOUT PRIOR AGREEMENT AND WRITTEN PERMISSION OF FORD PERFORMANCE PARTS © Ford Motor Company 2020

12. Release the clips and remove the scuff plate trim panel. Don't break the clips during assembly and disassembly

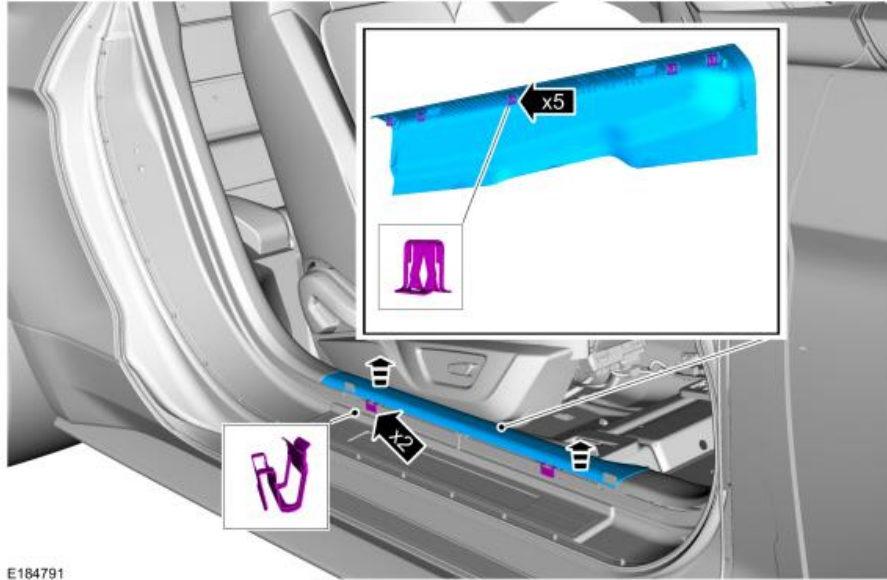

Ford Factory Shop Manual purchase options www.motorcraftservice.com

NO PART OF THIS DOCUMENT MAY BE REPRODUCED WITHOUT PRIOR AGREEMENT AND WRITTEN PERMISSION OF FORD PERFORMANCE PARTS © Ford Motor Company 2020

13. Position aside the safety belt guide, release the clips and remove the quarter trim panel. Don't break the clips during assembly and disassembly

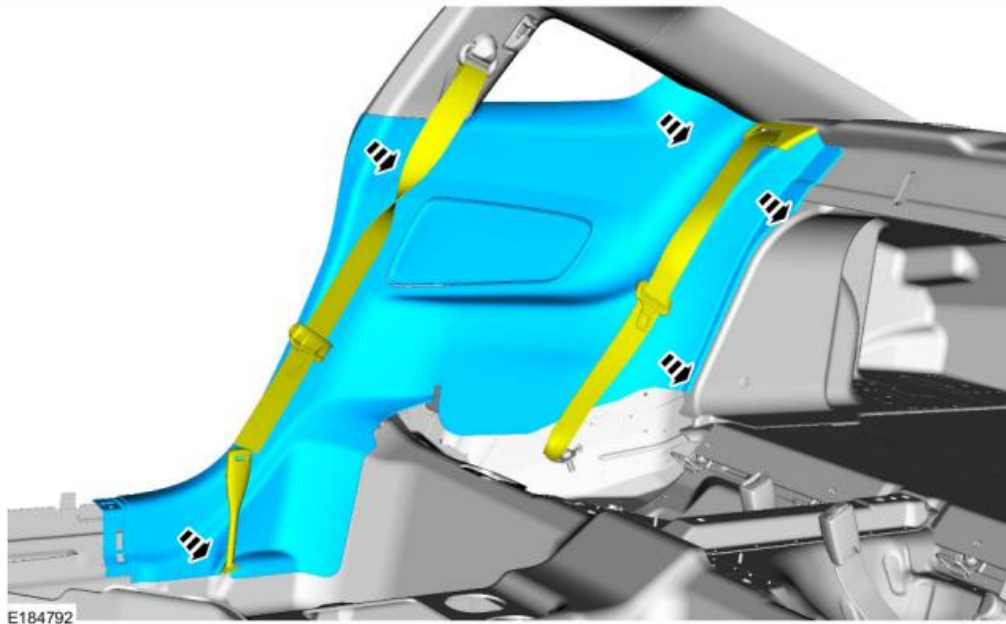
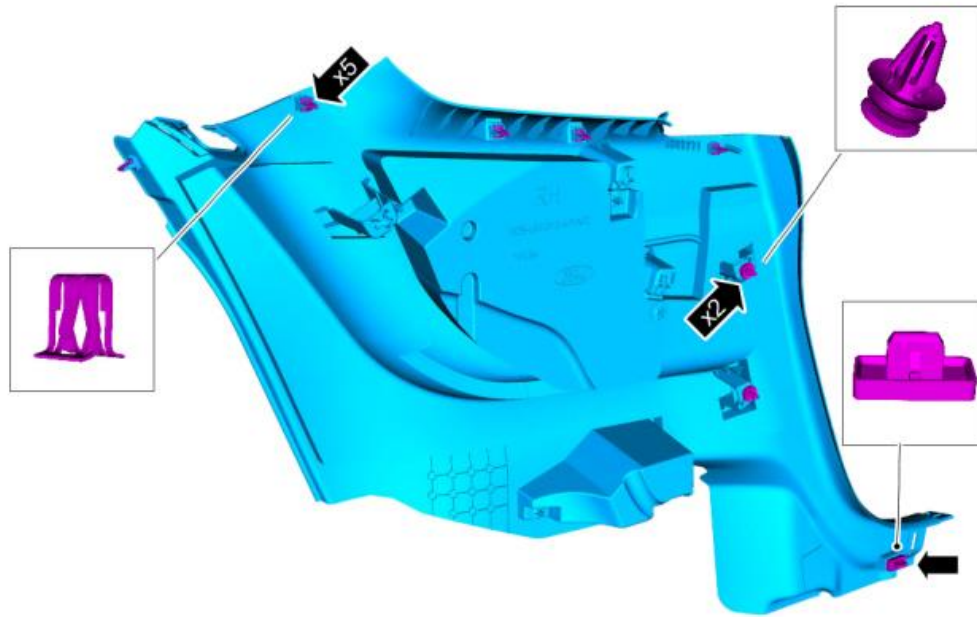

Ford Factory Shop Manual purchase options www.motorcraftservice.com

NO PART OF THIS DOCUMENT MAY BE REPRODUCED WITHOUT PRIOR AGREEMENT AND WRITTEN PERMISSION OF FORD PERFORMANCE PARTS © Ford Motor Company 2020

14. Remove the parcel shelf by removing both push-pins. Discard push-pins.

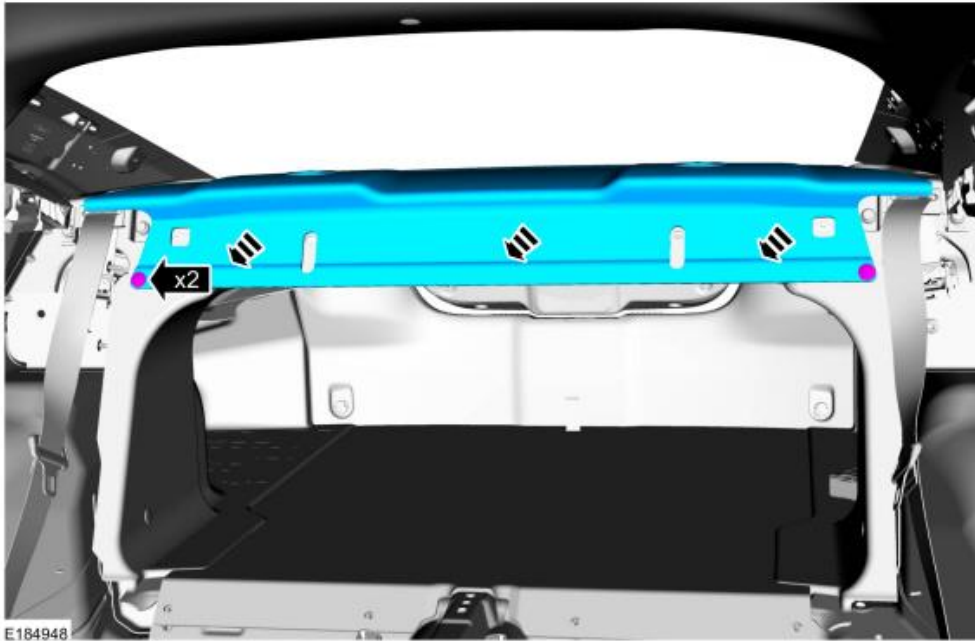

15. *RH shown, LH similar.* Remove the bolts and the seatbelt retractor.

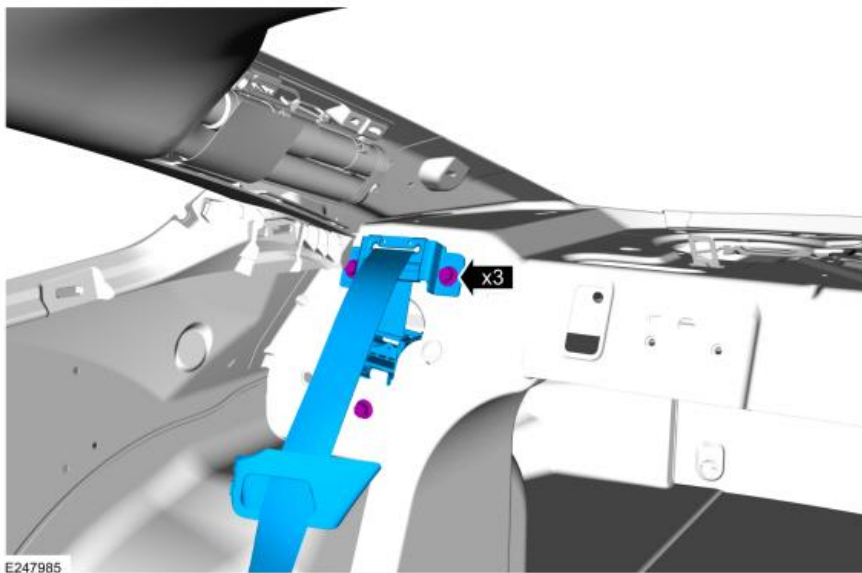

Ford Factory Shop Manual purchase options www.motorcraftservice.com

NO PART OF THIS DOCUMENT MAY BE REPRODUCED WITHOUT PRIOR AGREEMENT AND WRITTEN PERMISSION OF
FORD PERFORMANCE PARTS © Ford Motor Company 2020

16. Remove backrest strikers by removed both bolts on both the right and left side.

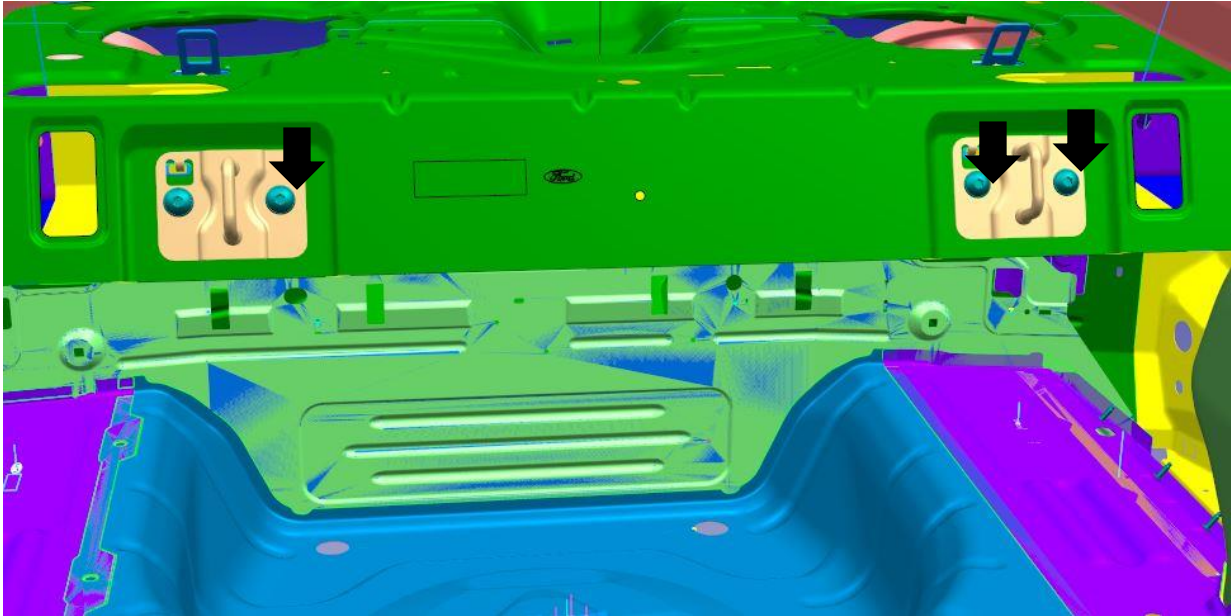

Ford Factory Shop Manual purchase options www.motorcraftservice.com

NO PART OF THIS DOCUMENT MAY BE REPRODUCED WITHOUT PRIOR AGREEMENT AND WRITTEN PERMISSION OF
FORD PERFORMANCE PARTS © Ford Motor Company 2020

Seat Deletion Installation

17. Install Parcel tray from the Seat Deletion Kit . Fix parcel shelf to the vehicle with the push-pins provided in the kit.

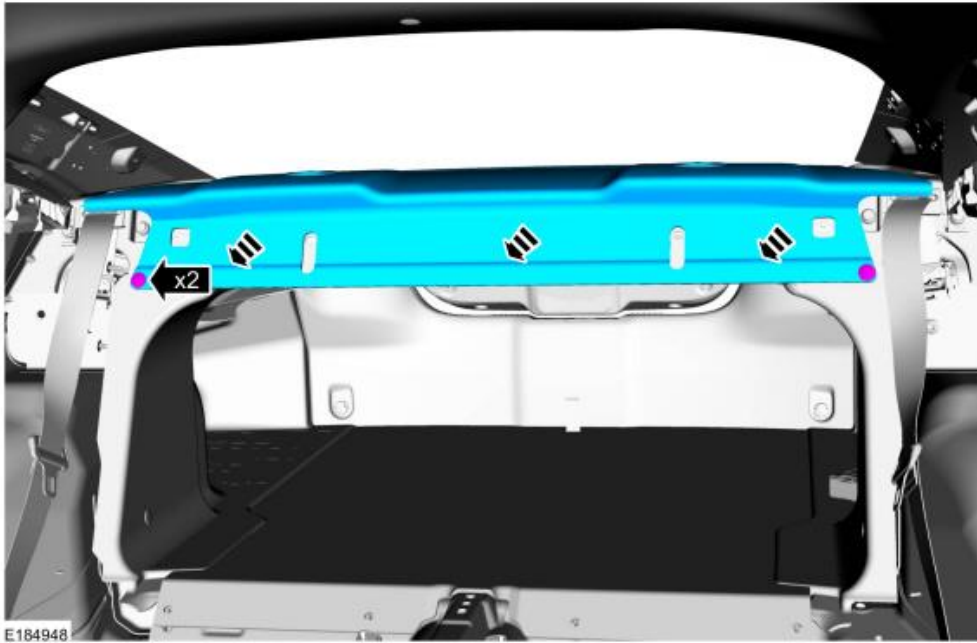

18. Install removed trim panels in the following order:
1. Quarter Trim Panel – Reversal of Step 13
 2. Scuff Plate – Reversal of Step 12
 3. C-Pillar – Reversal of Step 11. Ensure tether clip is properly secured

Ford Factory Shop Manual purchase options www.motorcraftservice.com



FORD PERFORMANCE

M-6346612-GT





Model Year 2018, 2019 and 2020

Product Name: Mustang rear seat deletion kit OE

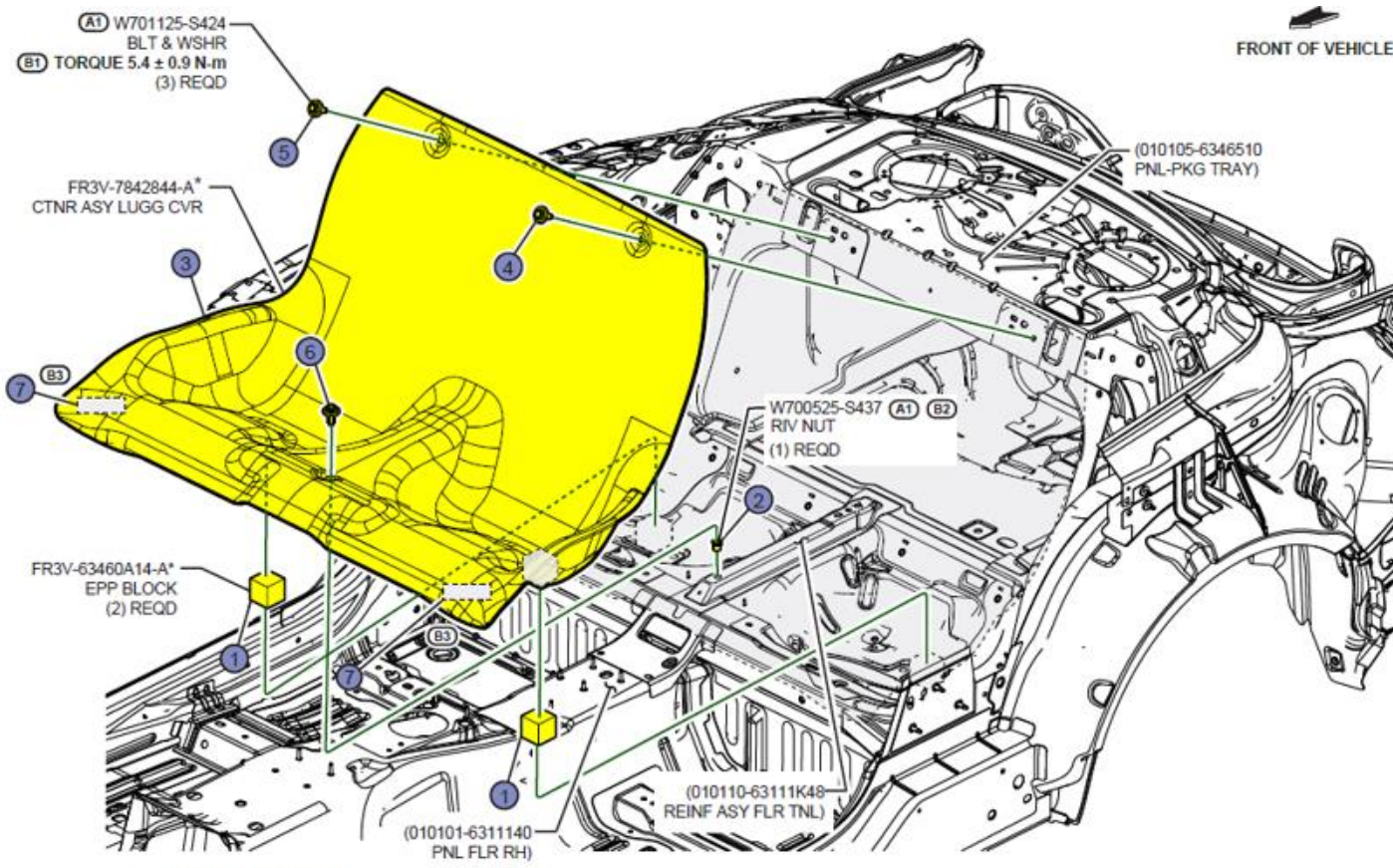
NO PART OF THIS DOCUMENT MAY BE REPRODUCED WITHOUT PRIOR AGREEMENT AND WRITTEN PERMISSION OF FORD PERFORMANCE PARTS © Ford Motor Company 2020

19. Install Centre luggage cover as per below instruction



1. Install 2 Foam blocks – Remove release paper and stick blocks in place on floor 
2. Install Rivet Nut.  (Rivet Nut Tool required to Install)
3. Load Seat delete cover into car
4. Install Driver side Bolt  (Torque 5.4 ±0.9 Nm)
5. Install Passenger side Bolt  (Torque 5.4 ±0.9 Nm)
6. Install Bottom Bolt  (Torque 5.4 ±0.9 Nm)
7. Remove release paper on Velcro on bottom side of seat delete 2 places and press seat delete firmly to quarter trim

Ford Factory Shop Manual purchase options www.motorcraftservice.com

NO PART OF THIS DOCUMENT MAY BE REPRODUCED WITHOUT PRIOR AGREEMENT AND WRITTEN PERMISSION OF
FORD PERFORMANCE PARTS © Ford Motor Company 2020

20. Fix cover body side trim panel on both LH and RH side

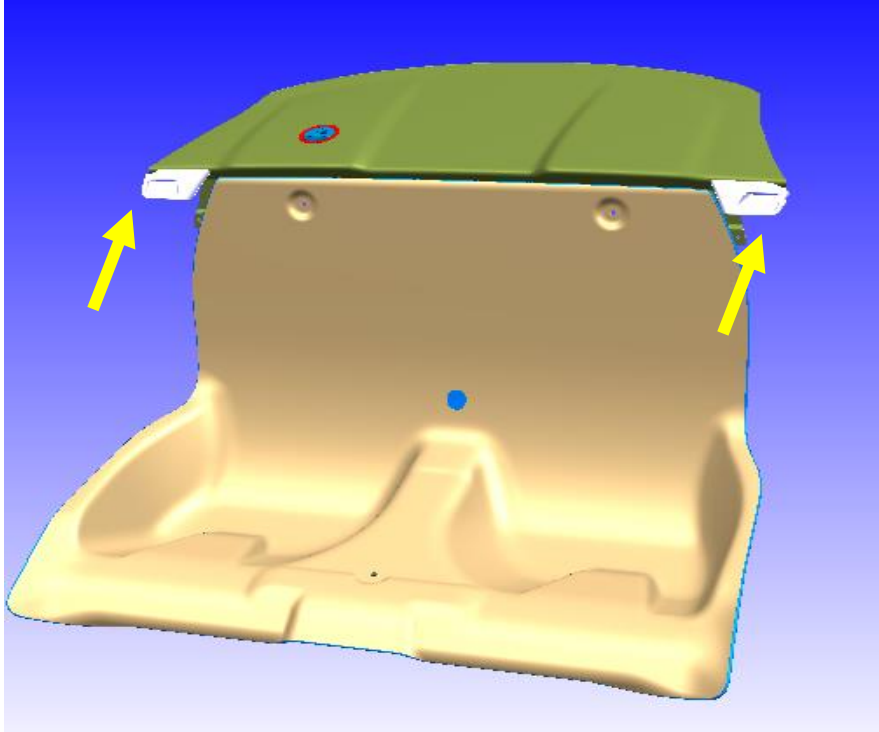

Installation complete